

DGH CORPORATION  
P. O. BOX 5638  
MANCHESTER, NH 03108

**D2000 SERIES  
PROGRAMMING MANUAL**

REVISED 6/01/94



## TABLE OF CONTENTS

CHAPTER 1	Linear Scaling	1-1
	Nonlinear Functions	1-3
CHAPTER 2	Block Diagram	2-2
	Programming Table	2-3
	Breakpoints	2-7
CHAPTER 3	BreakPoint Command	3-1
	MiNimum Command	3-2
	MaXimum Command	3-2
CHAPTER 4	Programming Software	4-1
	General Guidelines	4-1
	Function Programming	4-4
	Linear Scaling	4-7
CHAPTER 5	Programming Steps	5-3
	Examples	5-6



# Chapter 1

## Introduction

The D2000 series of intelligent analog-to-computer interfaces are designed to solve many difficult interfacing problems that cannot be performed with existing standard interfaces. The D2000 series may be programmed to create custom transfer functions to interface to non-standard sensors or to scale the outputs to any engineering units desired.

The D2000 series is an enhancement of the D1000 series of standard interfaces. The D2000 series is similar to the D1000 series in every respect except that the D2000 interfaces allow custom input-to-output transfer functions. As shipped from the factory, the D2000 modules operate in the same manner as their D1000 counterparts. For example, a D2111 shipped from the factory contains the same transfer function as a D1111 module; in this case they are both  $\pm 100$  mV inputs and communicate with RS-232. Before any attempt is made to program a D2000, you must first be familiar with the operation of a D1000 module as described in the D1000 manual.

The D2000 contains built-in commands to create custom functions. All programming is performed through the communications port of the D2000 module. There is never any need to open the module case. Modules may be re-ranged remotely as many times as desired. Transfer function data values are stored in nonvolatile memory to retain the scaling even if power is removed.

### Linear Scaling

The basic concept of the D2000 series is to create interfaces which output data in application specific engineering units that may be instantly read and interpreted without any data conversion necessary by a host computer. In fact, the D2000 interfaces may be used with a dumb terminal to provide data readings in easy-to-understand engineering units. For example, a typical pressure sensor might provide a 1 to 5V. linear output for pressures of 0 to 1000 psi. Using a D1131 module or an unprogrammed D2131 unit the output data would look like this:

Pressure (psi)	Sensor Output	D2131 Output (mV)
0	1V	+01000.00
500	3V	+03000.00
1000	5V	+05000.00

The standard output of the D2131 reads out in units of millivolts. Even though the D2131 will faithfully output the sensor voltage, the real parameter of interest is pressure, not voltage, and the voltage readings may be difficult to

interpret. To make the output data more readable, the D2131 may be programmed to output the data values in units of pressure:

Pressure (psi)	Sensor Output	D2131 Output (psi)
0	1V	+00000.00
500	3V	+00500.00
1000	5V	+01000.00

In some cases, the desired output may be more specific to a particular application. Assume that the same pressure sensor is used to measure the “fullness” of a pressure vessel, such as a cylinder of compressed air. The D2131 could be scaled to output in units of “percent” and in this case we will assume that if the cylinder reads 750 psi it is 100% full:

Pressure	Volts	Output (%)
0	1	+00000.00
375	2.5	+00050.00
750	4	+00100.00

## Nonlinear Functions

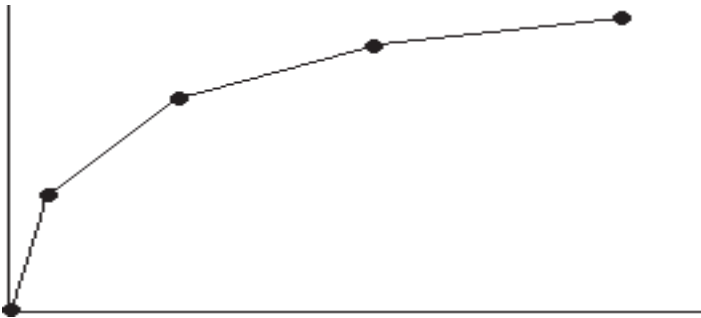
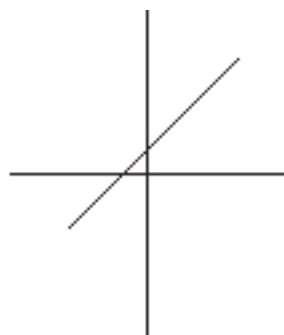

Figure 1 Piece-wise Linear Approximation.

As we have shown with the linear pressure sensor example, the output may be scaled to any units we desire. However, the real power of the D2000 series is that they may be programmed to provide a nonlinear transfer function. This capability may be used to provide outputs in engineering units for nonlinear sensors. The D2000 uses a linear piece-wise approximation technique to describe nonlinear functions. Up to 24 linear segments may be used to approximate a function, as shown in Figure 1. Figure 2 shows some of the variety of curves that may be programmed into the D2000.

The D2000 modules may also be programmed in the field to specific test inputs where the actual nonlinearity is not known.



Linear Scaling

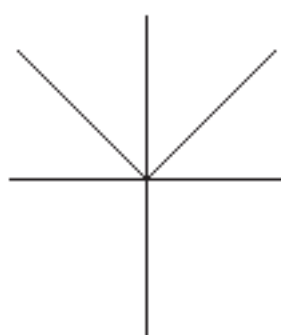

Absolute Value

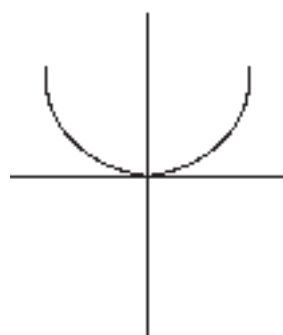

Square

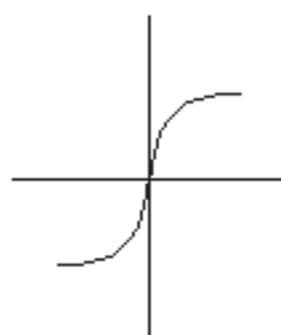

Sine

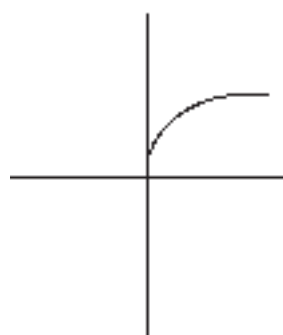

Square Root



Polynomial

Figure 2 Example Curves.





## Chapter 2

### Theory of Operation

The D2000 performs all scaling functions in firmware using the module's internal microprocessor. All scaling and nonlinear function data is stored in a table contained in EEPROM nonvolatile memory. Scaling data stored in the memory will remain intact indefinitely even if power is removed. D2000 modules may be re-scaled up to 10,000 times.

All re-scaling operations are performed with simple commands given to the module through its communications port. The D2000 series command set encompasses all the the D1000 commands plus additional commands to perform function programming. There is no need to open or have access to the module to perform re-scaling. In many cases the modules may be re-scaled remotely after they have been installed. Detailed descriptions of the D2000 programming commands are given in Chapter 5.

Figure 3 is a simplified block diagram of the D2000, showing only the portions related to re-scaling. The  $\mu\text{P}$  reads the raw Analog-to-Digital Converter (ADC) data after every conversion. The  $\mu\text{P}$  takes the raw ADC data and looks it up in a table held in EEPROM. The table contains entries which map the raw ADC data to user-defined output data values scaled in engineering units. If an exact match is not found, the data is interpolated between the two closest table entries. The resulting data in engineering units is stored in a memory buffer where it may be read by the Read Data (RD) or New Data (ND) Commands.

Note that the re-scaling operation acts on the output of the analog-to-digital converter. The basic input-to-output transfer function of the ADC is fixed and cannot be changed. For example, a D2131 module with a  $\pm 5\text{V}$  input range cannot be re-scaled to  $\pm 10\text{V}$  or any other range. Analog input scaling is performed by selecting the D2000 model that best matches the sensor signal. The ADC data is then manipulated with the function table to provide output data in engineering units.

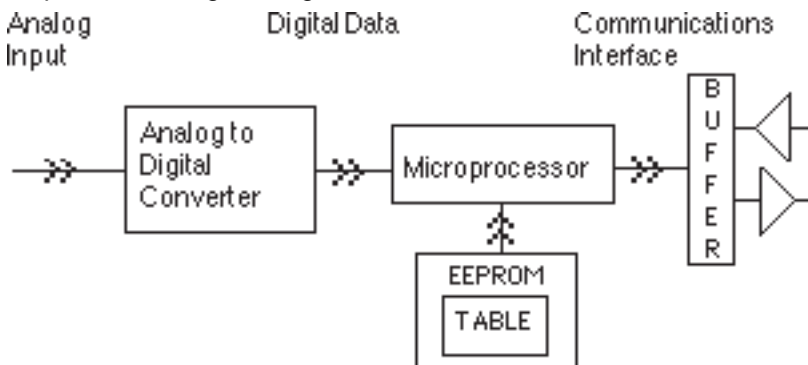

Figure 3. D2000 Series Block Diagram

**Programming Table**

Figure 4 shows a programmer's model of the table used to program the input-output transfer function of the D2000. The table values are intentionally left blank so that it may be copied and used as a worksheet to help program the modules.

	ANALOG INPUT	DATA OUTPUT
MINIMUM	$X_{MIN}$	$Y_{MIN}$
MAXIMUM	$X_{MAX}$	$Y_{MAX}$
BREAKPOINT 00	$X_{00}$	$Y_{00}$
BREAKPOINT 01	$X_{01}$	$Y_{01}$
BREAKPOINT 02	$X_{02}$	$Y_{02}$
BREAKPOINT 03	$X_{03}$	$Y_{03}$
BREAKPOINT 04	$X_{04}$	$Y_{04}$
BREAKPOINT 05	$X_{05}$	$Y_{05}$
BREAKPOINT 06	$X_{06}$	$Y_{06}$
BREAKPOINT 07	$X_{07}$	$Y_{07}$
BREAKPOINT 08	$X_{08}$	$Y_{08}$
BREAKPOINT 09	$X_{09}$	$Y_{09}$
BREAKPOINT 0A	$X_{0A}$	$Y_{0A}$
BREAKPOINT 0B	$X_{0B}$	$Y_{0B}$
BREAKPOINT 0C	$X_{0C}$	$Y_{0C}$
BREAKPOINT 0D	$X_{0D}$	$Y_{0D}$
BREAKPOINT 0E	$X_{0E}$	$Y_{0E}$
BREAKPOINT 0F	$X_{0F}$	$Y_{0F}$
BREAKPOINT 10	$X_{10}$	$Y_{10}$
BREAKPOINT 11	$X_{11}$	$Y_{11}$
BREAKPOINT 12	$X_{12}$	$Y_{12}$
BREAKPOINT 13	$X_{13}$	$Y_{13}$
BREAKPOINT 14	$X_{14}$	$Y_{14}$
BREAKPOINT 15	$X_{15}$	$Y_{15}$
BREAKPOINT 16	$X_{16}$	$Y_{16}$

Figure 4. Breakpoint Table.

The two most important points in the table are the Minimum and Maximum points. These two table entries specify the minimum and maximum endpoints of the transfer function curve. For instance, a D2121 has a range of  $\pm 1V$ , and the standard table values are:

	Analog Input	Data Output
Minimum	-1V	-01000.00
Maximum	+1V	+01000.00

Plotted on a graph (Figure 5), these two points specify the endpoints of the transfer curve. In this case, the analog input variable  $X$  is in terms of voltage. The  $X$  values in the table specify the minimum and maximum voltages that may be applied to the analog input that will result in a linearized output. (The  $X$  voltage values are actually stored in memory in terms of ADC binary data). Voltage values applied to the analog input that are more negative than  $X_{min}$  will result in an overload output of -99999.99. Similarly, voltage values greater than  $X_{max}$  will result in +99999.99.

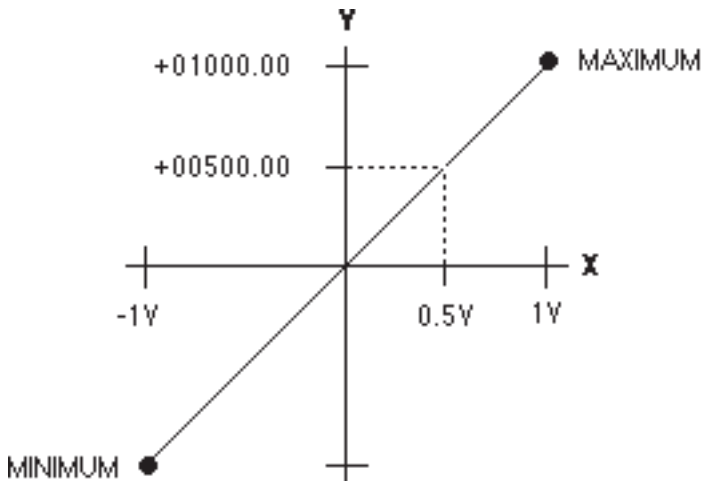

Figure 5. Function Endpoints

The corresponding  $Y$  values in the table specify the output data of the minimum and maximum points. In this case, a -1V input corresponds to an output of -01000.00mV. The  $Y$  values are always stored in the standard data format of sign, 5 digits, decimal point and two additional digits.

The minimum and maximum points are the only table values necessary to specify a linear transfer function. For analog input values between  $X_{min}$  and  $X_{max}$ , the output values are determined by linearly interpolating between the minimum and maximum points. For instance, in the case of the D2121,

an analog input value of +.5V is linearly interpolated to an output value of +00500.00 (Figure 5).

It should be apparent at this point that a D2000 module may be re-scaled by modifying the minimum and maximum values in the table. This may be accomplished by using the Minimum (MN) command and the Maximum (MX) command. Using the D2121  $\pm 1$  volt module as an example, we may use the MN and MX commands to alter the table to look like this:

	Analog Input	Data Output
Minimum	0V	+00100.00
Maximum	+1V	+00800.00

In this case the minimum point is 0V, corresponding to the output data +00100.00. The maximum point is +1V input and +00800.00 output. The graph of this equation is shown in Figure 6.

By changing the minimum and maximum values in the table, an infinite

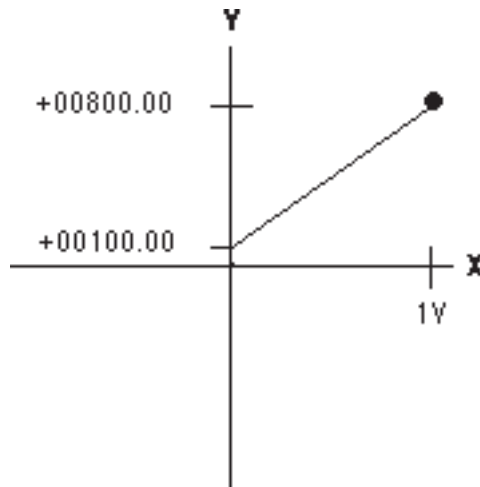

Figure 6

number of linear functions may be specified, bounded by X values of  $\pm 1V$  and Y values of  $\pm 99999.99$ . Figure 7 shows a few possibilities.

The exact procedure necessary to program the maximum and minimum points is described in Chapter 5.

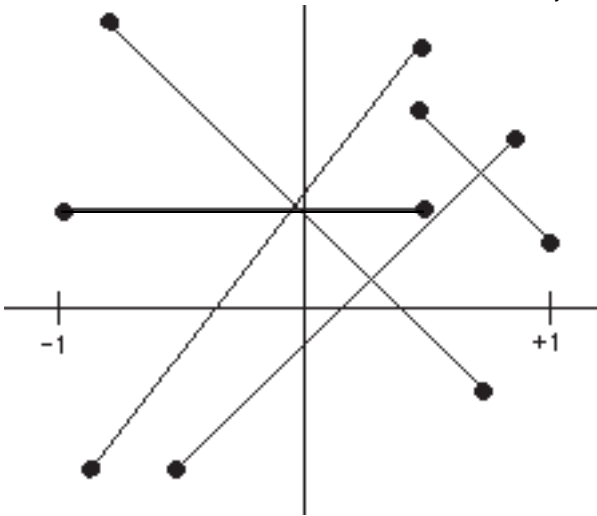

Figure 7. Examples of Linear Functions.

### Breakpoints

From Figure 4, we can see that most of the transfer function table is reserved for “Breakpoints”. Breakpoints are used to modify the basic linear curve defined by the Minimum and Maximum points to create nonlinear functions.

Nonlinear functions in the D2000 are approximated by using linear segments which are specified by the data values held in the Breakpoint Table. Up to 23 breakpoints may be programmed to specify up to 24 linear segments. Figure 8 illustrates the action of the breakpoints. Figure 8a shows a basic linear transfer function described by the Minimum and Maximum points. Figure 8b shows the effect of one breakpoint used to modify the linear function. Notice that the breakpoint has created a nonlinear function described by two linear segments joined at the breakpoint. Figure 8c shows that two breakpoints may be used to specify a nonlinear curve described by three linear segments. Up to 23 breakpoints may be used to create complex nonlinear curves.

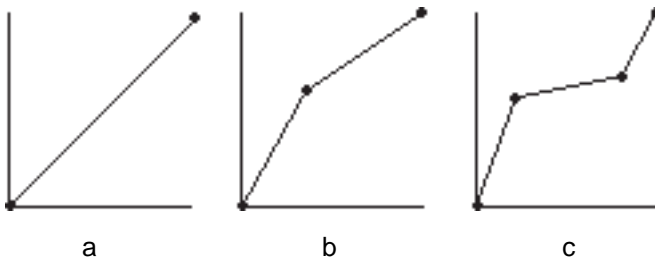

Figure 8. Breakpoint Examples

Breakpoints are stored in the EEPROM table in the same fashion as the minimum and maximum points. Each breakpoint is described by an X-Y pair specifying the analog input value at which the breakpoint occurs and the corresponding output data value. When the microprocessor reads the analog (X) data from the ADC, it searches the breakpoint table to find the X value closest to the input data. The micro then linearly interpolates between two breakpoints to calculate the resulting output data.

Any number of breakpoints up to 23 values may be specified. The breakpoint table must be filled progressively starting with Breakpoint 00 to Breakpoint 16 (hex). Unused or "erased" breakpoints are not used in the function calculation.

Let's use the D2121  $\pm 1V$  module again as an illustrative example to show the effect of a breakpoint. Figure 9 shows the D2121 function table with 1 breakpoint programmed:

	<u>Analog Input</u>	<u>Data Output</u>
Minimum	-1V	-01000.00
Maximum	+1V	+01000.00
Breakpoint 00	+0.2V	+00800.00
Breakpoint 01	-----	-----
.....		
.....		

Breakpoints 01 through 16 (hex) are erased and do not enter the function calculation. The Minimum and Maximum table entries contain the standard data values of  $\pm 01000.00mV$ . The new curve is shown in Figure 9.

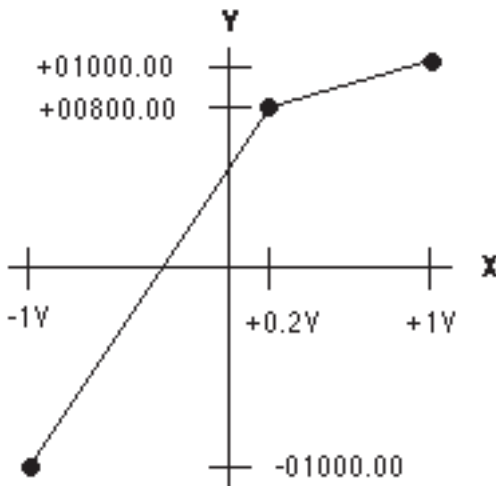

Figure 9

Notice how the breakpoint has affected the whole curve, creating a nonlinear function. Here are a few samples of the input-output values that may be obtained from this curve:

<u>Analog Input</u>	<u>Data Output</u>
-.8V	-00700.00
-.6V	-00400.00
-.4V	-00100.00
-.2V	+00200.00
0V	+00500.00
+.2V	+00800.00
+.4V	+00850.00
+.6V	+00900.00
+.8V	+00950.00

The procedure to create a breakpoint table is detailed in Chapter 4.

# Chapter 3

## Command Set

### D2000 COMMAND SET

The D2000 module series incorporates the same command set as the D1000 series, with new commands added to facilitate custom range programming. The added D2000 commands are used only for programming. For normal operational commands, refer to the D1000 manual.

**CAUTION: THE D2000 PROGRAMMING COMMANDS MUST BE USED WITH CARE. EACH OF THE COMMANDS IS CAPABLE OF DESTROYING FACTORY CALIBRATION.**

All of the commands added to the D2000 series are write-protected to guard against accidentally altering data values stored in the module's EEPROM. Therefore, all programming commands must be preceded with a Write Enable (WE) command.

All of the D1000 command-response protocol rules apply to the D2000.

This section is intended only to describe the new commands. For programming information refer to Chapter 5.

### BREAK POINT (BP)

Nonlinear functions may be approximated in the D2000 by describing the function curve with a series of line segments (see Figure 1). The line segments are programmed into the D2000 using the BreakPoint (BP) command. A breakpoint specifies the intersection between two linear segments used to approximate the nonlinear transfer function. Up to 23 breakpoints may be used to specify 24 linear segments in a curve.

To program a breakpoint, a known analog stimulus must be applied to the sensor input of the D2000 module. This specifies the input variable (X-axis) location of the breakpoint. The corresponding output data (Y-axis) of the breakpoint is specified as an argument to the BreakPoint (BP) command.

Example: (Spaces have been added to the command for clarity)

**Command:**     \$1 BP 03 +00100.00

**Response:**     \*

**Command:**     #1 BP 03 +00100.00

**Response:**     \*1BP 03 +00100.00FA (FA = checksum)

The first two characters following the "BP" command specify the breakpoint number. Up to 23 breakpoints may be programmed into the D2000. In the sample command above, breakpoint number "03" is being specified. Breakpoint numbers are expressed in two-digit hexadecimal notation, ranging from "00" to "16" for a total of 23 (decimal) points. During a normal



programming operation, breakpoints are entered in sequence in progressively-increasing X values starting from the minimum value (see Minimum (MN) command). Breakpoint programming must start with Breakpoint "00". It is not necessary to specify all the breakpoints; any number up to 23 may be used. However, a breakpoint sequence must start at "00" and be entered sequentially. Any remaining breakpoints may be left unspecified.

Following the breakpoint number, the output (Y-axis) data must be specified. The data must be in standard D1000 format: sign, five digits, decimal point, 2 digits. The output data specifies the module's output response for the test stimulus applied to the module input.

Before setting the breakpoints with the BreakPoint (BP) Command, the overall function span must be specified by the MiNimum (MN) and MaXi-mum (MX) commands. (See Chapter 5 for programming instructions.)

### Erase Breakpoints (EB)

The EB command erases all previously entered breakpoints from the module's EEPROM. Erased data cannot be recovered. Therefore, before using the EB command, be prepared to re-program all of the breakpoints in the unit. The S1000 Utility Software can be used to save factory calibration data values. The EB command is used to provide a clean slate before entering a new breakpoint sequence. Previous end-point data entered by the MiNimum (MN) and MaXi-mum (MX) commands are not affected.

**Command:** \$1EB

**Response:** \*

**Command:** #1EB

**Response:** \*1EBE2 (E2 is the checksum)

### MiNimum (MN)

The MiNimum (MN) command is used to define an endpoint of a transfer function programmed into a D2000 module. The minimum endpoint defines the most negative value allowed on the analog input before an overload will occur.

In effect, the minimum value is the starting breakpoint in a programmed transfer function. To use the MiNimum (MN) command, a known analog test stimulus must be applied to the analog input of the module. The test stimulus must correspond to the most negative value of the desired analog input range. The analog input stimulus specifies the starting input value (X-axis) of the transfer function. The test input must lie within the factory-specified full

scale input range of the module.

The argument of the MN command specifies the starting output value (Y-axis) of the transfer function.

**Command:** \$1MN -00100.00

**Response:** \*

**Command:** #1MN -00100.00

**Response:** \*1MN-00100.00A2 (A2 is the checksum)

### **MaXimum (MX)**

The MaXimum (MX) command specifies the most positive analog input allowed before an overload indication will occur. The MaXimum command also defines the positive end point of a transfer function programmed into the SCM9B-2000. To perform a MaXimum command, a known analog stimulus must be applied to the sensor input of the SCM9B-2000 unit. This test input must correspond to most positive value of the programmed transfer function. The analog test signal must remain within the factory-specified input range of the SCM9B-2000 module. The analog input establishes the maximum input value (X-axis) for the transfer function. The maximum output value (Y-axis) is specified as the argument of the MaXimum command.

**Command:** \$1MX +00500.00

**Response:** \*

**Command:** #1MX +0500.00

**Response:** \*1MX+00500.00AE (AE is the checksum)



# Chapter 4

## Programming

This section will cover the mechanics of programming a custom transfer function into the D2000. All programming is performed through the communications port of the D2000 using a dumb terminal or a computer operating as a dumb terminal. In field installations where AC power is not readily available, programming may be accomplished with standard battery-operated ASCII terminals. Since all programming is accomplished through the communications port, access to the module is not necessary and ranging may be accomplished remotely.

### Programming Software

Although all programming functions may be accomplished with a dumb terminal, the task may be greatly simplified with the use of utility software running on a computer. S1000 utility software is provided free of charge and will run on many of the popular personal computers. The software provides many enhancements that are not available through manual programming. In many applications the D2000 modules may be programmed strictly through software methods without the need for external excitation sources.

### GENERAL GUIDELINES

#### Input Scaling

The full scale analog input characteristics of a D2000 module may not be altered by the user. Input scaling is accomplished by selecting the correct D2000 model for the application. Programming a D2000 involves altering the scaling of the unit's A/D converter output. There is no provision for changing the gain or offset of the analog circuitry.

#### Excitation

When the D2000 modules are programmed manually with a terminal, external excitation sources are necessary to establish calibration points within the module. Excitation may be provided by standard voltage, current and frequency calibration sources. The final absolute accuracy of the module is directly dependent on the accuracy of the excitation sources. In some cases, the excitation may be generated directly by the system being monitored. In situations when excitation sources are not available or impractical, modules may be programmed with S2000 programming software without excitation.

## Output Data Format

One of the preliminary decisions to be made before programming is how the output data will be structured. All D1000/2000 sensor modules communicate data in a fixed format of sign, five digits, decimal point, and two additional digits; +00100.00 is an example. The fixed format is used to simplify software in host computers. Despite the fixed format, the programmer has a certain amount of flexibility to structure the output data for the best compromise between resolution and readability. For example, an output indication of +.05 volts could be structured in three different output formats:

+00000.05	(+.05 volts)
+00050.00	(+50 millivolts)
+50000.00	(50,000 microvolts)

The first consideration must be the resolution or the number of output counts available in the output structure. If the overall function span is 0 to +50 millivolts, the first example would only yield 5 counts from +00000.00 to +00000.05. In most applications this resolution would not be acceptable. The next obvious output structure is to output the data in units of millivolts, as shown in the second example. This format would give us 5,000 counts of resolution. Finally, the third example expresses the output data in units of microvolts to give a possible resolution of five million counts.

The second factor that must be considered is the performance limitations of the A/D converter. The best resolution of the ADC is 32,768 counts. Resolution is degraded by round-off errors, noise, etc., so that a practical expectation for usable resolution would be in the range of 5,000 to 20,000 counts. Output resolution may be limited by picking a suitable output format or by using the appropriate 'displayed digits' setup as described in the D1000 Setup section.

In the present example of the 0 to 50mV output, probably the best compromise is to use the millivolt form to represent the data. This gives 5,000 count resolution in easy to interpret units of millivolts. In this case the 'displayed digits' setup should be programmed to display all digits.

It may be tempting to use the microvolt output format in an effort to extract the maximum counts of resolution, but the units digit will tend to be noisy. The uncertainty of the units digit may be counteracted somewhat by using large amounts of digital filtering in the module setup. In this case the setup data should specify a 'displayed digits' setting of the first five digits only, since the digits to the right of the decimal point have no meaning. Also, the microvolt format is a bit more awkward to interpret than the millivolt format.

In some cases it may require a bit of creative thinking to develop a suitable output format. For example, a D2000 module may be required to output data

in units of specific gravity. In a typical application, the specific gravity output may range between .5 and 2. The most obvious output format would have the output data ranging from +00000.50 to +00002.00. This format gives only 150 counts of resolution between the minimum and maximum outputs. However, since the specific gravity of water is defined to be 1, the output may be scaled in units of “percent of water”. The specific gravity of water would then be 100 percent. The output data in ‘percent’ units would range from +00050.00 to +00200.00. This format allows up to 15,000 counts of resolution and reads out in units that may be easily interpreted.

### Linearity

The analog-to-digital converter used in the D2000 has a typical integral nonlinearity of .1% of full scale. At the factory the ADC linearity is corrected by using breakpoints to reduce the nonlinearity to .01%. If the breakpoint table is erased with the Erase Breakpoints (EB) command, the linearity correction is lost. In some cases when linear re-scaling is performed, the programmer may take advantage of the factory linearity correction (Example L-4). If less than the full analog input scale is used, the linearity correction should be erased with the EB command. Linearity may be improved with the use of new breakpoints (Example N-5).

### SCM9B-2000 Function Programming

The D2000 transfer function may be programmed by modifying the function table with the MiNimum (MN), MaXimum (MX) and BreakPoint (BP) commands. All three commands operate on the same basic principle. Each command is used to specify an input-output (X,Y) data pair in the function table. To perform a programming command, a known analog excitation must be applied to the analog input of the D2000 module. The excitation may be a voltage, current, frequency, or the output of a resistive bridge, depending on the specific D2000 module type. The known excitation value is used to create the “X” values in the function table. The “Y” table values are loaded with data specified in the command argument.

For example, suppose we have a D2121  $\pm 1V$  module and we’d like to program the minimum table value to  $X_{min} = -.5V$ ,  $Y_{min} = -00100.00$ . Apply -.5 volts to the module input with a calibrated voltage source. Perform the MiNimum (MN) command with the  $Y_{min}$  value as the data argument in the MN command:

<b>Command:</b>	<b>\$1WE</b>	<b>(MN is write-protected)</b>
<b>Response:</b>	*	
<b>Command:</b>	<b>\$1MN-00100.00</b>	
<b>Response:</b>	*	

When the module executes the MN command, the microprocessor performs two functions. First, it reads the data produced by the A/D converter with the -.5V input. The A/D converter data is stored as Xmin in the function table. The micro then reads the argument of the MN instruction, which in this case is -00100.00, and stores this value in the table as Ymin. This completes the definition of the new minimum point. The module will immediately use this new minimum point data in calculating output data.

Note that the MN command will write over any previous data in the table. The old data is permanently lost. This is also true with the MaXimum (MX) and BreakPoint (BP) commands. Since the MN, MX, and BP commands affect the calibration of the module, they must not be used indiscriminately unless you are prepared to re-calibrate the unit.

### **Linear Scaling**

Rescaling the D2000 to a linear transfer function is the easiest and most common way to reprogram the module. The linear scale function is defined by specifying the two endpoints of the linear function (see Figure 7). Any linear function within the analog input range of the module may be defined.

Custom scaling requires a calibrated analog input signal to define the endpoints of the linear transfer function. The signal could be a voltage, current, or frequency depending on the specific model type. The MiNimum and MaXimum commands are used to program the end point data into the modules's memory.

Programming procedures:

1. Make sure the module has not been previously programmed with Break Point (BP) Commands. If it has, clear the breakpoints with the Erase Breakpoints (EB) command.
2. Clear any data in the output offset register with the Clear Zero (CZ) command.
3. Determine the endpoints which will be used to define the linear function. The analog input values must lie within the full scale operating range of the module. The analog inputs used to determine the endpoints will also define the display overload outputs of the module. Construct an output data format that is best suited for your application.
4. Apply a calibrated analog signal to the module input corresponding to the most negative input of the desired linear scale. Perform a Minimum (MN) command to store the function endpoint into the modules's memory.
5. Apply a calibrated analog signal to the module input corresponding to the

most positive analog input value. Perform a Maximum (MX) command to load the endpoint data into the module memory.

6. Verify that the transfer function has been correctly loaded into the module by applying test inputs to the module and reading out the data with the Read Data (RD) command.

### Example L-1

Reprogram a D2251, 4-20mA module to output data in terms of percent; that is, 4mA will read out to be 0% and 20mA will read out as 100%.

1. If the module had been previously programmed with breakpoints, erase the function table with the Erase Breakpoints (EB) command:

**Command:** \$1WE

**Response:** \*

**Command:** \$1EB

**Response:** \*

2. Clear any offset data with the Clear Zero command:

**Command:** \$1WE

**Response:** \*

**Command:** \$1CZ

**Response:** \*

3. The minimum analog input in this case is 4mA. Any current less than 4mA will result in a negative over-range (-99999.99). The maximum positive input is 20mA. Since the minimum value of 4mA corresponds to 0%, the appropriate output data would be +00000.00. The output data corresponding to 20mA is +00100.00. This data format gives us whole units of "percent" to the left of the decimal point. To get the maximum resolution from the module, set up the number of displayed digits with the SetUp (SU) so that all digits are displayed.

**Command:** \$1WE

**Response:** \*

**Command:** \$1SU310701C2 (typical)

**Response:** \*



4. Apply exactly 4mA to the current input of the module. Program the endpoint with the MiNimum command:

**Command:** \$1WE

**Response:** \*

**Command:** \$1MN+00000.00

**Response:** \*

5. Apply exactly 20mA to the module input and store the maximum endpoint with the MaXimum (MX) command:

**Command:** \$1WE

**Response:** \*

**Command:** \$1MX+00100.00

**Response:** \*

6. Verify the module response by testing it with various inputs within its range:

Input Current	Output Data
8mA	+00025.00
12mA	+00050.00
16mA	+00075.00

Rescaling is now complete.

### Example L-2

A paddle-wheel flow sensor will be used to monitor the flow of water in a pipe. The characteristics of the sensor and the size of the pipe results in an output frequency of 10 Hz per gallon per minute. The operating range is from 1 to 20 gallons per minute.

We would like to scale a D2000 module to output data in units of .1 gallons.

The logical module choice in this application is the D2601 frequency input module. The frequency output of the flow sensor will range from 10 Hz to 200 Hz, easily within the 5 Hz to 20 kHz range of the D2601.

1. Erase Breakpoints:

**Command:** \$1WE

**Response:** \*

**Command:** \$1EB

**Response:** \*

2. Clear Zero:

**Command:** \$1WE

**Response:** \*

**Command:** \$1CZ

**Response:** \*

3. The minimum endpoint in this case is 10 Hz corresponding to an output of +00001.00 gpm. The maximum frequency at 20 gpm is 200 Hz. The maximum output data is +00020.00. To get .1 gpm resolution, set up the module to display six digits:

**Command:** \$1WE

**Response:** \*

**Command:** \$1SU31070182 (typical)

**Response:** \*

4. Using a calibrated frequency generator, apply 10 Hz to the module input. Set the minimum point:

**Command:** \$1WE

**Response:** \*

**Command:** \$1MN+00001.00

**Response:** \*

5. Set the frequency generator to 200 Hz to program the maximum point:

**Command:** \$1WE

**Response:** \*

**Command:** \$1MX+00020.00

**Response:** \*

6. Use the frequency generator to verify a few points in the scale:

Analog Input	Data Output
30 Hz	+00003.00
100 Hz	+00010.00
155 Hz	+00015.50

Programming is now complete and the D2601 can be attached to the flow sensor.

**Example L-3**

In many cases the analog calibration values may be produced directly by the sensors to be used in a system. The module may be re-ranged in the field to encompass any errors due to sensor inaccuracies.

In this example, we wish to use a pressure sensor to measure the volume of water in a cylindrical tank that is 10 feet tall with the capacity of 1500 gallons. The pressure sensor is mounted at the bottom of the tank so that it will produce an output corresponding to the height of water in the tank. The pressure sensor chosen produces 1V @ 0 psi and 5V @ 10 psi. A full tank with 10 feet of water will produce 4.335 psi (1 ft = .4335 psi), well within the range of the pressure sensor. A D2131  $\pm 5V$  input module will be used as the interface.

## 1. Erase Breakpoints:

**Command:** \$1WE  
**Response:** \*

**Command:** \$1EB  
**Response:** \*

## 2. Clear Zero:

**Command:** \$1WE  
**Response:** \*

**Command:** \$1CZ  
**Response:** \*

3. To produce the analog Xmin and Xmax endpoint values, we will use the actual water levels in the tank to produce a calibration pressure. The accuracy of the pressure transducer is not important, as long as it is stable and linear. To set the minimum value, we will empty the tank and set the minimum value to +00000.00. The maximum value will be programmed with the tank full and the maximum output data will be set to +01500.00 gallons. In this case an output resolution in units of gallons is acceptable and we can set up the module so that 5 digits are displayed. The digits to the right of the decimal point will always read out "00".

**Command:** \$1WE  
**Response:** \*

**Command:** \$1SU31070142 (typical)  
**Response:** \*

4. With the tank empty, program the minimum point:

**Command:** \$1WE

**Response:** \*

**Command:** \$1MN+00000.00

**Response:** \*

5. Fill the tank with water and program the maximum point:

**Command:** \$1WE

**Response:** \*

**Command:** \$1MX+01500.00

**Response:** \*

6. Verify the scaling. In this case, it is difficult to verify the scaling quickly and accurately. A “ballpark” check can be made by letting water out of the full tank and checking to see if the module output readings are “reasonable”. A more accurate check can be made by filling the tank with known amounts of water and verifying the output readings.

#### Example L- 4

A SCM9B-2251 4-20mA module will be used to provide a computer interface to an existing process 4-20mA signal. The loop transmitter produces a linear 4-20mA signal corresponding to a sensor temperature of 0-200 degrees C. In this case we'd like to take advantage of the factory linearity correction in the SCM9B-2251 for greater accuracy. To do this, we must use the same analog input minimum and maximum points as programmed at the factory. The SCM9B-2251 minimum and maximum points are 0mA and 25mA. The 4-20mA span of the process transmitter must be extrapolated to 0-25mA to provide the correct data when using the MN and MX commands. The transfer relationship of the 4-20mA transmitter can be described by the equation:

$$T = 12.5 \times \text{mA} - 50$$

Plug values of 0mA and 25mA into the equation to derive extrapolated values of T:

$$T = 12.5 \times (0) - 50 = -50$$

$$T = 12.5 \times (25) - 50 = +262.5$$

These values will be used in the MN and MX instructions.

Program the module:

1. In this case it is assumed that the SCM9B-2251 is fresh from the factory and it still contains linearity correction in the breakpoint table. In order to take advantage of the linearity correction, the breakpoints will not be erased.

2. Clear zero:

**Command:** \$1WE

**Response:** \*

**Command:** \$1CZ

**Response:** \*

3. The minimum endpoint has been extrapolated to be -00050.00 @ 0mA. The maximum point is +00262.50 @ 25mA. We'll setup the module to display temperature with .1 degree resolution:

**Command:** \$1WE

**Response:** \*

**Command:** \$1SU31070142 (typical)

**Response:** \*

4. Apply 0mA (open circuit) to the current input and program the minimum point:

**Command:** \$1WE

**Response:** \*

**Command:** \$1MN-00050.00

**Response:** \*

5. Apply exactly 25mA to the current input to program the maximum point:

**Command:** \$1WE

**Response:** \*

**Command:** \$1MX+00262.50

**Response:** \*

6. Apply test currents to the module to verify the scaling:

Apply 4mA to the input:

**Command:** \$1

**Response:** \*+00000.00

Apply 20mA to the input:

**Command:** \$1

**Response:** \*+00200.00

# Chapter 5

## Nonlinear Programming

Nonlinear functions may be created by first specifying a linear function with the MiNimum (MN) and MaXimum (MX) commands. The linear function is then modified by using the BreakPoint (BP) command. Almost any practical nonlinear function may be approximated provided it satisfies two rules:

1) The nonlinear function must be totally enclosed by the rectangular area defined by the minimum and maximum points. Figure 10 gives examples of the "rectangular area".

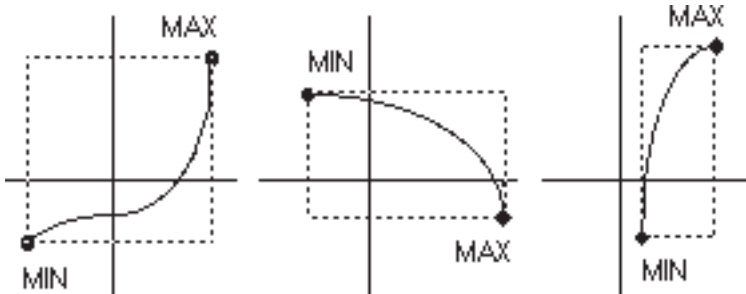

Figure 10. Example of "Rectangular Area".

Figure 11 illustrates a function that is not possible since a portion of the curve lies outside of the rectangle. In most cases this limitation may be overcome by simply re-arranging the curve so that the rectangular area is larger. Figure 12 shows the same curve as Figure 11, but slightly modified to allow it to be programmed into the D2000.

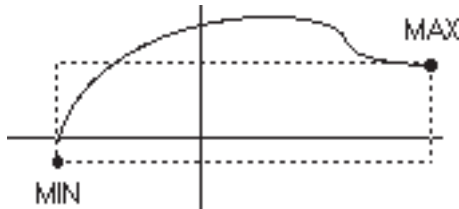

Figure 11. Illegal Function.

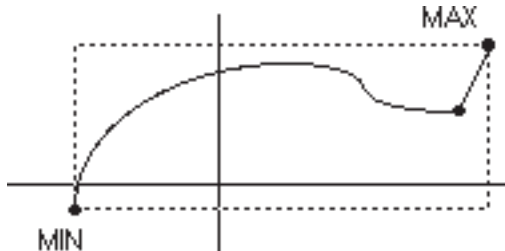

Figure 12 Modified Function.

2) The nonlinear function must be a single-valued function of  $X$ . That is, for each input value, there can exist only one output value. Figure 13 shows two illegal functions. This limitation is seldom encountered in natural phenomenon.

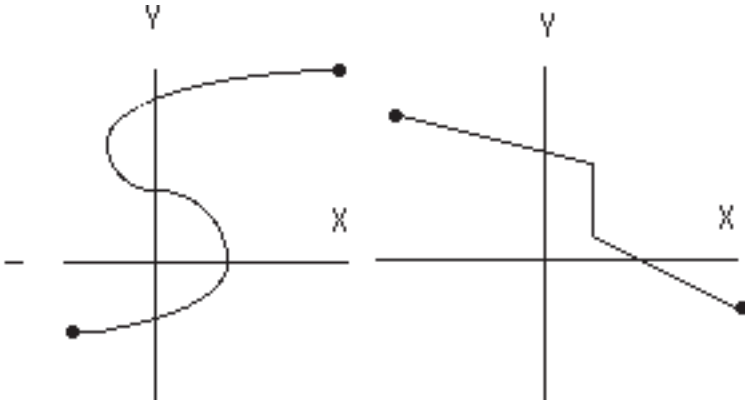

Figure 13. Examples of Illegal Functions.

### Programming Steps

- 1) Define the function data points to be programmed
- 2) Erase breakpoints
- 3) Clear zero
- 4) Use SetUp (SU) command to set number of displayed digits
- 5) Program the minimum endpoint
- 6) Program the maximum endpoint
- 7) Program breakpoints
- 8) Verify the function

Step 1. Define the function data points to be programmed. The ability of the D2000 to simulate a nonlinear transfer function is highly dependent on the location of the breakpoints selected by the programmer. The ultimate conformity to the desired function is directly dependent on the linear-segment approximation loaded into the module. The D2000 gives the programmer a great deal of flexibility in how the breakpoints are placed. In areas where the function curves sharply, or where greater accuracy is desired, breakpoints may be placed close together for better conformity to the desired function. The chart in Figure 4 is a handy form to help organize the breakpoint data.

Step 2. The existing breakpoint table should be cleared by using the Erase Breakpoints (EB) command. This command will completely erase the breakpoint table. Any previous breakpoint information will be permanently lost.

**Command:** \$1WE  
**Response :** \*

**Command:** \$1EB  
**Response:** \*

Step 3. Clear any data stored in the output offset register by using the Clear Zero (CZ) command:

**Command:** \$1WE  
**Response:** \*

**Command:** \$1CZ  
**Response:** \*

Step 4. Use the SetUp (SU) command to program the correct number of displayed digits:

**Command:** \$1WE  
**Response:** \*

**Command:** \$1SU31070182 (typical)  
**Response:** \*

Step 5. Start the function programming by setting the minimum point using the MiNimum (MN) command as described in the linear scaling section.

Step 6. Set the maximum function point with the MaXimum command as described in the linear scaling section.

Step 7. Use the BreakPoint (BP) command to program the nonlinear function into memory. Apply the proper excitation to the module for Break-point 00. Use the BreakPoint command to enter the data into memory:

**Command:** \$1WE  
**Response:** \*

**Command:** \$1BP00+00100.00  
**Response:** \*



It may be useful to verify that the breakpoint data has indeed been recorded in memory. Without changing the excitation, read the output data:

**Command:** \$1  
**Response:** \*+00100.00

The output data should match the data programmed with the Breakpoint command.

Once Breakpoint 00 has been entered, proceed to Breakpoint 01. Set the analog excitation for the correct value for Breakpoint 01. Load the breakpoint into memory using the BreakPoint command. Be sure to specify '01' in the BreakPoint command:

**Command:** \$1WE  
**Response:** \*  
**Command:** \$1BP01+00200.00  
**Response:** \*

Verify that the data has been entered properly:

**Command:** \$1  
**Response:** +00200.00

Continue this process until all breakpoints have been programmed.

Step 8. Test the input-output transfer function of the module to verify that the breakpoint data has been entered properly. Large errors in the output data are generally caused by improper breakpoint programming. In most cases it is not necessary to repeat the whole breakpoint sequence if the error is confined to one portion of the curve. Breakpoints may be re-programmed individually to correct any errors. However, it is not possible to insert new breakpoints in between existing points of the table to correct for a poor initial function approximation.

### Example N-1

A voltage-output pressure sensor produces 0V @ 100 psi and 5V @ 600 psi. Its output characteristic is nonlinear and may be described by the equation:

$$P = 100 + 80V + 4V^2$$

where

V = sensor output in volts

P = pressure in psi

A simple linear equation may be derived by using the endpoint data:

$$P = 100 + 100V$$

Unfortunately, describing the sensor output with this equation results in a 25 psi error at  $V = 2.5V$ .

To obtain better accuracy, we may approximate the quadratic transfer function using breakpoints. Since the sensor output range is 0–5V, the D2131 with an input range of  $\pm 5V$  is most suitable for this application. For simplicity, we will use only four evenly-spaced breakpoints to plot the function. This will result in a function approximation with a maximum error of 1 psi. For better conformity, more breakpoints may be used.

1. First, construct the function table:

	Analog Input	Output
Minimum	0V	+00100.00
Maximum	5V	+00600.00
Breakpoint 00	1V	+00184.00
Breakpoint 01	2V	+00276.00
Breakpoint 02	3V	+00376.00
Breakpoint 03	4V	+00484.00

Notice that we've broken up the curve into five evenly-spaced voltage segments by using four breakpoints. The breakpoint output values were obtained by plugging the breakpoint voltage values into the quadratic equation that describes the sensor.

2. Prepare the D2131 by erasing any stored breakpoints: (All programming commands must be preceded by a Write Enable (WE) command. In the interest of simplicity, the Write Enable commands are not shown in this or any of the following examples.)

**Command:** \$1EB  
**Response:** \*

3) Clear any data in the output offset register:

**Command:** \$1CZ  
**Response:** \*

4) We will setup the output data to display psi with .1 resolution:

**Command:** \$1SU31070182 (typical)  
**Response:** \*

(The SU data may vary depending on your particular module setup. See the Setup section in the D1000 manual.)

5. Apply 0 volts (short) to the input of the D2131 to enter the minimum point of 100 psi:

**Command:** \$1MN+00100.00  
**Response:** \*

6. To set the maximum point, apply 5V to the input and program the maximum point to be 600 psi:

**Command:** \$1MX+00600.00  
**Response:** \*

7. Program the first breakpoint:

Apply 1 volt to the input and perform the BreakPoint command:

**Command:** \$1BP00+00184.00  
**Response:** \*

Verify the breakpoint data:

**Command:** \$1  
**Response:** \*+00184.00

Repeat the procedure for the remaining breakpoints:

Apply 2 volts to the input:

**Command:** \$1BP01+00276.00  
**Response:** \*

**Command:** \$1  
**Response:** \*+00276.00

Apply 3 volts to the input:

**Command:** \$1BP02+00376.00  
**Response:** \*

**Command:** \$1  
**Response:** \*+00376.00

Apply 4 volts to the input:

**Command:** \$1BP03+00484.00  
**Response:** \*

**Command:** \$1  
**Response:** \*+00484.00

The function programming is now complete.

8. The transfer function may be verified by applying test inputs to the module and obtaining output data. The data can then be compared to the original quadratic equation to check for conformity error.

Example:

Apply .5 volts to the D2131 input and read data:

**Command: \$1**

**Response: \*+00142.00**

To check, plug .5 volts into the quadratic equation:

$$P = 100 + 80 (.5) + 4 (.5)^2 = 141$$

The conformity error at this point is +1 psi.

### Example N-2

A pressure sensor rated for 0-200 psi has a nonlinear transfer function described by the relationship:

$$V = 4 \times 10^{-3} P + 5 \times 10^{-6} P^2$$

$$V = 0 \text{ to } 1 \text{ volts}$$

$$P = 0 \text{ to } 200 \text{ psi}$$

Use a D2121  $\pm 1V$  input module to linearize the sensor output and convert the data to engineering units.

This example differs from Example N-1 because the desired output data in psi is the independent variable in the equation. One solution to this problem would be to convert the equation to a form of  $P = f(V)$  and then proceed as we did in Example N-1. However, this kind of mathematical rigor is not necessary. To program the D2121, we simply need to construct a table of X,Y pairs. In this case, we may choose breakpoints to be in even intervals of psi, and then calculate the matching values of V. Our table with four breakpoints would look like this:

	Input	Output
Minimum	0V	+00000.00
Maximum	+1V	+00200.00
Breakpoint 00	.168V	+00040.00
Breakpoint 01	.352V	+00080.00
Breakpoint 02	.552V	+00120.00
Breakpoint 03	.768V	+00160.00

Notice that in this case, the breakpoints were selected by picking even intervals of pressure. The pressure values are then plugged into the sensor

equation to produce the breakpoint voltages. The mechanics of entering the breakpoints is the same as in Example 1.

If better conformity is required, more breakpoints may be used. However, breakpoints cannot be simply added to the table at random. Breakpoints must be entered in sequence starting at the minimum value and progress in ever-increasing values of the X variable. To obtain better conformity, a new function table must be started from the beginning. Therefore, to avoid needless trial and error, it is best to test the breakpoint table on paper to determine if the conformity error is acceptable. Another approach is to simply use all 23 breakpoints available for the best conformity.

For this example, we may improve the conformity error by using nine breakpoints:

	Input	Output
Minimum	0V	+00000.00
Maximum	1V	+00200.00
Breakpoint 00	.082V	+00020.00
Breakpoint 01	.168V	+00040.00
Breakpoint 02	.258V	+00060.00
Breakpoint 03	.352V	+00080.00
Breakpoint 04	.450V	+00100.00
Breakpoint 05	.552V	+00120.00
Breakpoint 06	.658V	+00140.00
Breakpoint 07	.768V	+00160.00
Breakpoint 08	.882V	+00180.00

### Example N-3

In many cases, the system transfer function may not be known. In these situations, a D2000 may be programmed empirically using test inputs derived by the system itself.

A standpipe in a municipal water system has an irregular shape, as shown in Figure 14. It is desirable to obtain a direct reading of the volume of water contained in the standpipe. Because of the shape, a simple water height measurement would give grossly inaccurate readings of volume. Also, the actual relationship of volume to height is complex and unknown.

The standpipe is 50 feet tall and has a known capacity of 30,000 gallons. A pressure sensor may be used at the base of the standpipe to obtain a reading of the water height. Since 1 foot of water produces a pressure of .4335 psi, the maximum pressure expected is  $50 \times .4335 = 21.7$  psi. The pressure sensor we will use produces 0–5 volts for pressures of 0–25 psi. A D2131  $\pm 5V$  input module will be used as the interface.

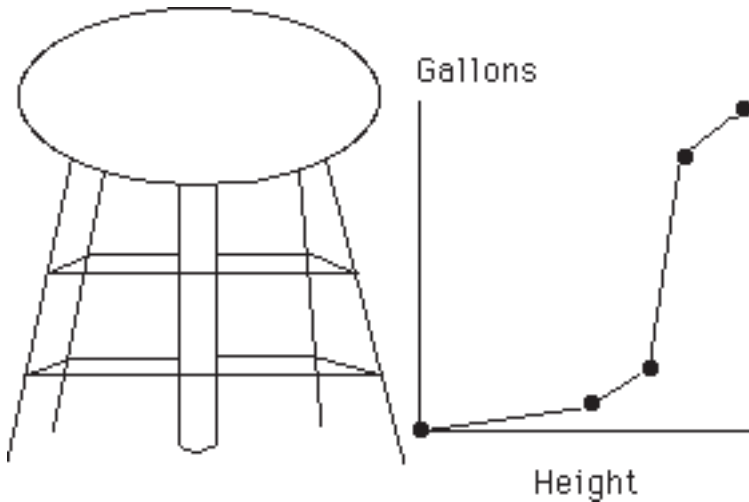

Figure 14. Scaling When Transfer Function is Unknown.

Install the pressure sensor and the D2131 in place at the standpipe. Prepare the D2131 by erasing breakpoints and clearing zero as detailed in Example N-1. In this case we will setup the D2131 to display four digits which will result in an output resolution of 10 gallons.

Start programming with the standpipe empty. Enter the minimum value:

**Command:**    **\$1MN+0000.00**  
**Response:**     \*

In this example, the maximum point may be programmed by filling the standpipe to obtain the maximum pressure output. However, this is awkward and unnecessary. Since the standpipe capacity is known to be 30,000 gallons and the pressure can never reach 25 psi, we can simulate a maximum that we know can never be attained. To do this we may apply 5V to the module input to simulate 25 psi. The 5V source does not have to be accurate. We can set the maximum value to 35,000 gallons, which is more than the standpipe can hold.

Disconnect the pressure sensor and apply 5V to the module input:

**Command:**    **\$1MX+35000.00**  
**Response:**     \*

Re-connect the pressure sensor to the D2131. Starting with the standpipe empty, we may begin to program the breakpoints. We will set a breakpoint every 1500 gallons for a total of 20 breakpoints.

To set the first breakpoint, fill the standpipe with 1500 gallons of water. Since we will be using actual volumes of water to 'calibrate' the standpipe, the accuracy at which we can measure 1500 gallons will greatly influence the final performance of the system.

With 1500 gallons in the standpipe used as the input excitation, program the first breakpoint:

**Command:** \$1BP00+01500.00  
**Response:** \*

Test:

**Command:** \$1  
**Response:** \*+01500.00

Fill the standpipe with an additional 1500 gallons to program the second breakpoint. The standpipe now holds 3000 gallons:

**Command:** \$1BP01+03000.00  
**Response:** \*

**Command:** \$1  
**Response:** \*+03000.00

Repeat these steps until the standpipe is full. For each step, fill the standpipe with an additional 1500 gallons and program the breakpoint with the accumulated amount of water in the standpipe. When the breakpoint programming is complete, the D2131 will give a very accurate indication of the volume of water in the standpipe directly in units of gallons.

In this example, the actual transfer function of the system is unknown. Instead, the function is plotted in the field by applying known inputs to the system. Note that the voltage produced by the pressure sensor does not have to be known to program the D2131. However it is wise to record the voltages produced by the sensor at each breakpoint. With this information, replacement D2131's may be programmed with a voltage source to avoid repeating the tank filling exercise.

#### **Example N-4**

Program a D2141  $\pm 10V$  input module to calculate the square root of the input signal from 0 to 10V. We'll keep the units in terms of millivolts so that the square root of 10,000 millivolts (10V) is 100. To simplify this example, we will create a function with nine breakpoints at even 1V intervals.

## 1. Construct the function table:

	Analog input	Data Output
Minimum	0V	+00000.00
Maximum	10V	+00100.00
Breakpoint 00	1V	+00031.62
Breakpoint 01	2V	+00044.72
Breakpoint 02	3V	+00054.77
Breakpoint 03	4V	+00063.25
Breakpoint 04	5V	+00070.71
Breakpoint 05	6V	+00077.46
Breakpoint 06	7V	+00083.67
Breakpoint 07	8V	+00089.44
Breakpoint 08	9V	+00094.87

## 2. Erase breakpoints:

**Command:** \$1EB  
**Response:** \*

## 3. Clear zero:

**Command:** \$1CZ  
**Response:** \*

## 4. Display all digits:

**Command:** \$1SU310701C2 (typical)  
**Response:** \*

## 5. Program minimum by applying 0V (short) to input:

**Command:** \$1MN+00000.00  
**Response:** \*

## 6. Program maximum by applying exactly 10 volts to the input:

**Command:** \$1MX+00100.00  
**Response:** \*

## 7. Program breakpoints:

Apply 1 volt to the input:

**Command:** \$1BP00+00031.62  
**Response:** \*



Apply 2 volts to the input:

**Command:**    **\$1BP01+00044.72**  
**Response:**     \*

Continue until all breakpoints are programmed.

8. Verify the transfer function.

To get better conformity more breakpoints may be programmed, especially near the minimum end of the scale where the function curvature is greatest. There is no particular requirement to have breakpoints at regular intervals. The breakpoint intervals may be varied to achieve the best overall conformity. Small breakpoint intervals assure better conformity in areas where the function curvature is the greatest.

### Example N-5

Breakpoints may be used to improve the linearity of a module in linear output applications.

The D2141 module programmed in Example N-4 is to be programmed back to its original  $\pm 10V$  input-output transfer function.

1. Define function data:

	Analog Input	Data Output
Minimum	- 10V	-10000.00
Maximum	+10V	+10000.00
	(No Breakpoints)	

2. Erase breakpoints.

3. Clear zero

4. Setup the displayed output for five digits:

**Command:**    **\$1SU31070142    (typical)**  
**Response:**     \*

5. Program minimum by applying exactly - 10V to the input:

**Command:**    **\$1MN-10000.00**  
**Response:**     \*

6. Program maximum by applying +10V to the input:

**Command:**    **\$1MX+10000.00**  
**Response:**     \*

7. There are no breakpoints to be programmed.

Analog Input	Data Output
- 5V	-05010.00
0V	-00020.00
+ 5V	+04990.00

During the verification process, we find that the module exhibits some errors. This is due to the .1% typical error inherent in the analog-to-digital converter. The nonlinearity may be corrected by using breakpoints. In this case, instead of using the breakpoints to create a nonlinear function, they will be used to 'straighten' the nonlinearity of the ADC. Only a few breakpoints are necessary to reduce the linearity error to .02 % or less. In this case we will use three breakpoints to linearize the module:

	Analog Input	Data Output
Minimum	- 10V	-10000.00
Maximum	+ 10V	+10000.00
Breakpoint 00	- 5V	-05000.00
Breakpoint 01	0V	+00000.00
Breakpoint 02	+5V	+05000.00

Since the minimum and maximum data have already been programmed, only Step 7 is necessary to program in the breakpoints.

After the breakpoints have been entered, verify the module transfer function:

Analog Input	Data Output
- 7.5V	-07502.00
0V	+00000.00
+7.5V	+07498.00

This time the module output is in error by .02 % or less due to linearizing effect of the breakpoints.

### Example N-6

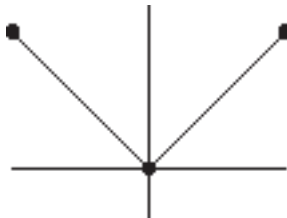

Figure 15. Absolute Value Function.

A D2141 module may be programmed to create an absolute-value function as shown in Figure 15. However, this function violates the 'rectangular area' rule. To overcome this limitation, the function may be re-drawn as shown in Figure 16. This curve satisfies the 'rectangular area' rule. The function table for this curve looks like this:

	Analog Input	Data Output
Minimum	- 10V	-00010.00
Maximum	+10V	+10000.00
Breakpoint 00	-9.990V	+09990.00
Breakpoint 01	0V	+00000.00

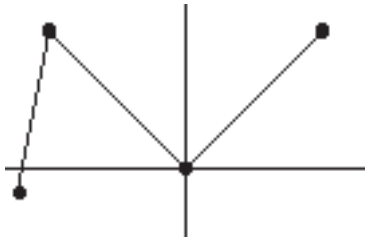

Figure 16. Modified Absolute Value Function.

The absolute-value function will be valid for inputs between - 9.990V and + 10V. This technique may be used for other functions that violate the 'rectangular area' rule.